



The Armament of Australia's VOC Ships

Wendy van Duivenvoorde

THE ARMAMENT OF AUSTRALIA'S VOC SHIPS

From the Verenigde Oostindische Compagnie ((VOC) shipwrecks found along the Western Australian Coast, *Batavia* (1629), *Vergulde Draak* (1656), *Zuiddorp* (1712), and *Zeewijk* (1727), several cannon and swivel guns have been raised. A number of cannon and swivel guns are known to have been raised from the Verenigde Oostindische Compagnie (VOC) shipwrecks *Batavia* (1629), *Vergulde Draak* (1656), *Zuiddorp* (1712), and *Zeewijk* (1727), found along the Western Australian Coast. This report discusses the armament of the four VOC ships and lists all cannon and swivel guns raised from their shipwreck sites.

The Commonwealth Government of Australia is the legal owner of all shipwreck cannon from Dutch VOC ships lying off the coast of Western Australia (*Historic Shipwrecks Act* 1976: Schedule 1, Articles 1 and 2). Cannon declared prior to or during the 1993/1994 Historic Shipwrecks Amnesty, however, can be legally held by custodians, who have a duty of care to protect and preserve the relics. Custodians can be private individuals or organizations. All cannon discussed in this report, unless noted differently, are registered and vested in the Commonwealth VOC shipwreck collection of the WA Museum.

GENERAL BACKGROUND

Batavia Ship Cannon

Twenty-eight guns were found on the *Batavia* shipwreck site, which include 21 made of iron, five of bronze, and two composite cannon, called mignons (Green 1989: 25–54).¹ The ship originally had two more cannon, one iron and one bronze, which were raised after the ship's wrecking by Commander-in-chief Francisco Pelsaert. These two cannon are listed in his overview of salvaged goods as one iron cannon of 3,310 pounds and one metal (i.e., bronze) cannon of 3,300 pounds (Roepert 1993: 219).² *Batavia*, therefore, originally carried at least 30 cannon. In a decree of the VOC's board of directors, the Gentlemen XVII, dating to 22 August 1630, the VOC's large Indiamen were ordered to be fitted with 32 cannon: 24 heavy iron cannon, six bronze cannon, and two mignons of iron or copper (Van Dam 1927: 507); the latter being composite cannon. Diverging from this particular VOC regulation, *Batavia's* equipment was short two iron cannon.

Sixteen of the 28 cannon on the wreck site were raised, including all of the bronze and composite cannon and nine iron cannon. The remaining 12 iron cannon were left as found on the site. Some of *Batavia's* iron cannon are still undergoing conservation treatment by the WA Museum's Department of Materials Conservation.

A comprehensive study of the *Batavia* cannon was published in Jeremy Green's book *The Loss of the Verenigde Oostindische Compagnie Retourschip Batavia, Western Australia 1629: An Excavation Report and Catalogue of Artifacts* (1989: 25–54).

Vergulde Draak Ship Cannon

Vergulde Draak was bought by the VOC Chamber of Amsterdam in 1653. The 260-ton ship was 137 Amsterdam feet (38.78 m) in length, 32 Amsterdam feet (9.05 m) in beam, and 13.5 Amsterdam feet (3.82 m) in height (Green 1977: 23).

To date, no contemporary references have been found providing information on *Vergulde Draak's* armament. Before the ship set sail, the Gentlemen XVII decreed

that armament specifications for all company ships would be made on an annual [ad hoc] basis determined by availability (Van Dam 1926: 508). For the smaller VOC ships, such as *Vergulde Draak*, this situation lasted throughout the Anglo-Dutch wars of the 17th century. In 1678, for the first time since 1653, the numbers of cannon for smaller VOC ships were once again specifically mandated. Due to a shortage of bronze cannon, they were to be armed with only 18 iron cannon (Van Dam 1926: 509).

Archaeological evidence indicates that *Vergulde Draak* originally carried at least 18 iron cannon. Furthermore, no bronze cannon are known to have been observed or raised from the *Vergulde Draak* site, and the ship may not have carried any due to the VOC's deficiency of bronze armament at that time. Unfortunately, inadequate details on the type and size of the ship's armament are known, since most iron cannon raised from the wreck were poorly preserved or did not receive proper conservation treatment.



James Henderson with the first *Vergulde Draak* cannon raised from the wreck site in 1964. Photographer: Merve Brown (Department of Maritime Archaeology, WA Museum, GT-H-011).

Prior to controlled archaeological management, at least one cannon was raised in 1964 by James Henderson, John Cowen and George Brenzi. The cannon was in good condition when recovered, but was seen to be exfoliating three months later in the backyard of George Brenzi. Eventually, it disintegrated due to a lack of conservation treatment. At that time, no conservation facilities were available in Western Australia, nor was there any expertise in the treatment of large ferrous objects from a marine environment. Shattered fragments from the gun's surface were donated to the WA Museum's collection in late 1960s. The actual remaining core of the cannon, however, reappeared many years later in the custodianship of Robert Muir, as declared during the 1993/1994 Historic Shipwrecks Amnesty (Amnesty certificate WA 0681,1994). It had been in his custodianship—on display in his backyard—for some thirty years.



The same *Vergulde Draak* cannon only a few years later in a badly deteriorated condition, in the custodianship of Robert Muir. Photographer: unknown, late 1960s (Department of Maritime Archaeology, WA Museum, W24-020).

A second, identical cannon (GT 1456) was raised from the *Vergulde Draak* shipwreck by the WA Museum in March 1970, and is displayed in the *Batavia* hull diorama of the Shipwreck Gallery at the Geraldton Museum. The cannon, still encapsulated in coral, was kept wet and brought to the Museum's conservation laboratory. Experts consulted in Europe recommended a heat treatment preservation technique, which was attempted with this cannon, but failed. Unfortunately, even though the technique had given satisfactory results on test samples, treatment instructions were not strictly followed at the foundry where the procedure was administered. As a result, the WA Museum established a, now internationally recognized, conservation program and employed in-house expertise for treatment of large ferrous objects from a marine environment.



Newspaper clipping on the *Vergulde Draak* cannon recovered in March 1970. The West Australian, Friday, 7 August 1970.

When the Department of Maritime Archaeology of the WA Museum (DMA) began the first archaeological excavation of *Vergulde Draak* in 1972, sixteen iron cannon were still *in situ* on the wreck. The DMA recovered two that season.

Zuiddorp Ship Cannon

The *Zuiddorp* ship, 1152 tons, is known to have carried a total of 40 cannon: 10 twelve-pounders, 22 eight-pounders, and 8 four-pounders (Playford 2006: 35; Bruijn et al. 1979: 2147.3). Ships built to the same charter as *Zuiddorp* were to be armed with 38 cannon according to VOC guidelines (Van Dam 1927: 510). The eight four-pounders were swivel guns located on *Zuiddorp*'s quarterdeck and included the only breech-loading cannon aboard the ship. Iron and bronze muzzle-loading cannon comprised all other armament. The swivel guns were made of bronze, as were two of the larger muzzle-loading cannon in the vicinity of the ship's compasses.

A single bronze cannon and two iron cannon have been recovered from the *Zuiddorp* shipwreck. In addition, the remains of at least seven bronze swivel guns were salvaged. Playford (2006: 35) states that four of the swivel guns would have been muzzle-loading and four breech-loading, but, in fact, six could be positively identified as muzzle-loading and only one as breech-loading. Three of the eight bronze swivel guns were recorded during the 1993/1994 Historic Shipwrecks Amnesty; all others were raised during WA Museum expeditions. One bronze muzzle-loading swivel gun, in the custody of Max Cramer, is on display in the WA Museum Geraldton (amnesty certificate WA 0561,1994). Today, at least, fifteen iron cannon and one bronze ship cannon remain *in situ* on the shipwreck site. All other cannon aboard *Zuiddorp* at the time of its sinking remain buried in sediments, lie encased in concretions or have completely eroded away in the dynamic and fierce surf zone of the shipwreck site. The latter is indicated by the severely eroded state of some of *Zuiddorp*'s other armament (for example, bronze cannon ZT 726, iron cannon ZT 3314, and swivel gun ZT 4161).

Zeewijk Ship Cannon

VOC ship *Zeewijk* was built for the chamber of Zeeland in 1725 (NA, item number 267, 23 February 1725; Bruijn et al. 1979: 2680.1). The 850-ton ship was armed with 36 iron and bronze cannon plus six breech-loading swivel guns (NA, item number 267, 10 July 1725).

At least 23 cannon have been observed on the *Zeewijk* shipwreck site by the WA Museum (Ingelman-Sundberg 1977: 229–30). Ten guns have been raised: four bronze breech-loading swivel guns and six iron cannon. One of the swivel guns was raised in 1840 by John Lort Stokes and the crew of the British survey ship HMS *Beagle* (ZW 1111). The ship's crew landed on the island where the marooned sailors from the *Zeewijk* had camped more than 100 years earlier and found numerous artifacts, including two Dutch *doits* dating to 1707 and 1720. Stokes knew of the *Zeewijk* wrecking event:

“This was a very interesting discovery, and left no doubt that we had found the island on which the crew of the *Zeewyk* were wrecked, in 1727, and where they remained so long, whilst building, from the fragments of their vessel, a sloop, in which they got to sea by the passage between Easter and Pelsart Groups, which has consequently been called *Zeewyk* Passage. The scene of their disaster must have been on the outer reef, a mile and threequarters south-west from Gun Island, along which ran a white ridge of high breakers.” (Stokes 1846: 149)

The swivel gun sailed with *Beagle* to England and ended up in the collection of the Tower of London (Blackmore 1976: 50–51). A replica of this swivel gun is part of the WA Museum's collection. The other three swivel guns, or sections thereof, are part of the Commonwealth collection of the WA Museum.

There have been several visits to Gun Island in the 20th century. In 1952, six cannon, three cylindrical pieces of iron, and two bundles of iron bars were located by the Royal Australian Navy (R.A.N) in the shallows on the inside of Half Moon Reef. The cannon may have been carried into the shallows by *Zeewijk's* crew in order to salvage and transport them to Batavia. The presence of the other iron artefacts indicates that the cannon could have washed over the reef when the ship broke up. Alternatively, the cannon may have been jettisoned in an attempt to refloat the *Zeewijk* (Ingelman-Sundberg 1978: 12–13).

Three of the six guns were raised by the R.A.N., of which two were donated to the WA Museum. The location of the third cannon is not known, nor have any specific details on this particular cannon survived. The other three iron cannon from the *Zeewijk* site were raised in 1962, by Trevor Sutcliffe, and 1963, by Hugh Edwards and the WA Newspapers.

So, only five of the six iron cannon raised from the *Zeewijk* shipwreck site survive today. Three of them belong to the Commonwealth collection of the WA Museum. The remaining two iron cannon were allocated to the ANCODS³ collection of the Sydney Australian National Maritime Museum (ZW 5574) and the Netherlands Government (ZW 5575). However, they are all physically present in Western Australia; four in the Shipwreck Galleries of the WA Museum in Fremantle, and one displayed outdoors on Geraldton's Marine Terrace in front of the library.

LIST OF VOC SHIPWRECK CANNON

The following of the VOC shipwreck cannon and swivel guns were raised from the shipwreck sites or the shallows nearby in the nineteenth and twentieth century.

Batavia Bronze Ship Cannon

1.

Number on site plan: 25

Registration number BAT 3627

Current location Geraldton Airport, Geraldton

History

This cannon was raised in 1963 and was registered into the collection of the Maritime Archaeology Department of WA Museum in April 1974. It is on loan to the Geraldton City Council. Initially on display outside the Country Women's Association Building in Geraldton, it was moved to the Geraldton Civic Centre sometime between 1984 and 1989. It was on display outside the centre, until being transferred to the arrivals terminal of Geraldton Airport in mid 2008.

Description

Bronze ship cannon from the Rotterdam Admiralty, made by Arent van der Put in 1616. Its dolphins are not preserved.

Dimensions

Dimensions: L. 3.20 m; bore diam. 0.151 m.

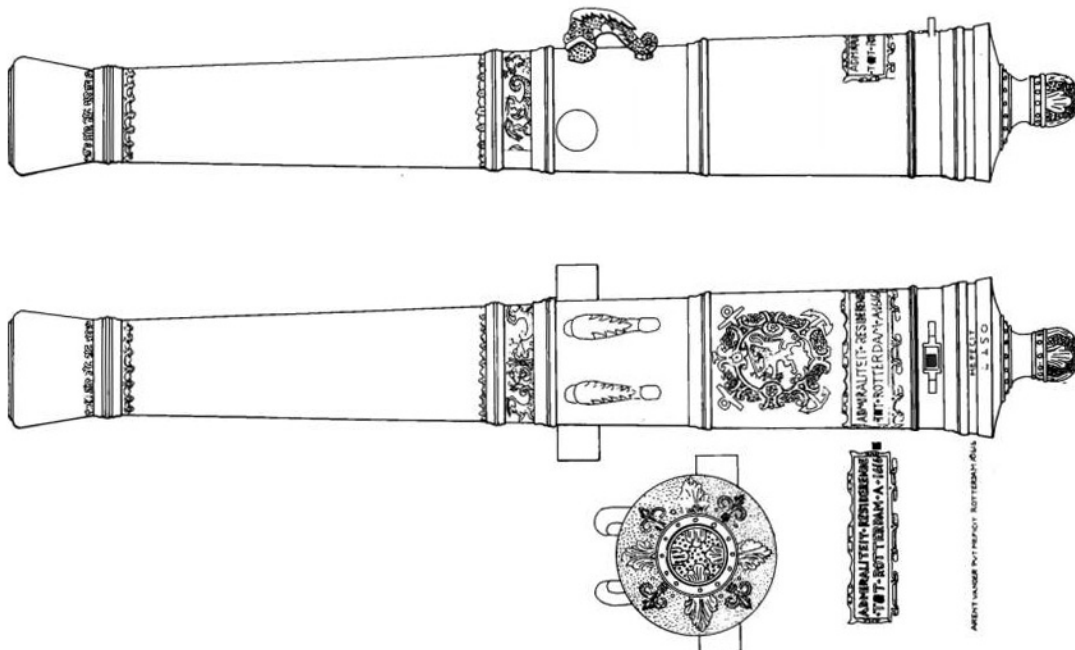

After Green 1989: 31

Batavia Bronze Ship Cannon

2.

Number on site plan: 24

Registration number BAT 3637

Current location *Batavia* Gallery, Shipwreck Galleries, WA Museum, Fremantle.

History This cannon was raised in 1963 and was registered into the collection of the Maritime Archaeology Department of WA Museum in April 1974.

Description Bronze ship cannon from the Rotterdam Admiralty, made by Conraet Antonisz. in 1603 or 1605. It is the oldest of the VOC shipwreck cannon found Australia.

Dimensions L. 3.525 m; bore diam. 0.12 m.

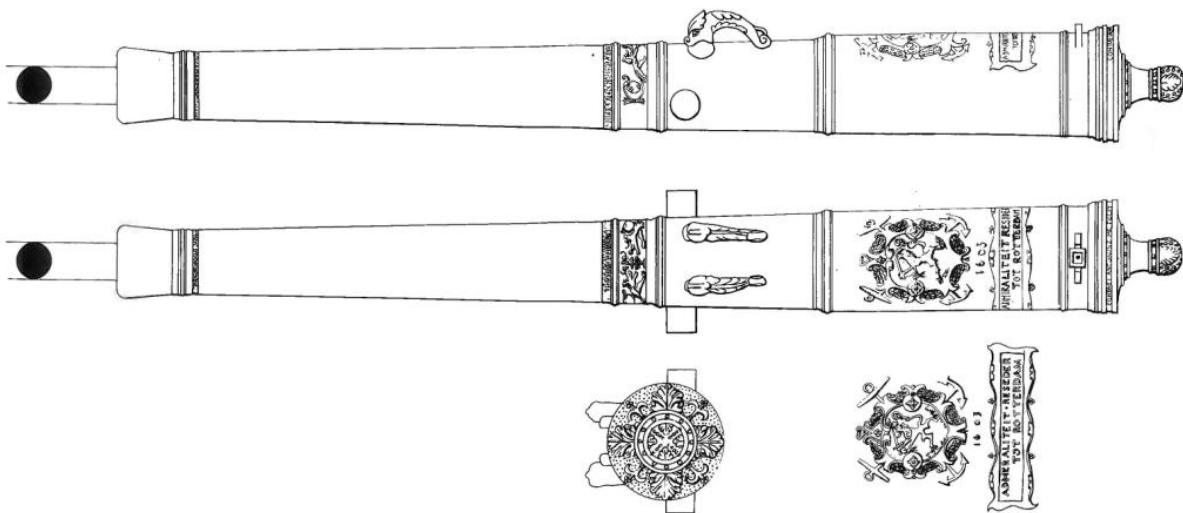

Green 1989: 29

Batavia Bronze Ship Cannon

3.

Number on site plan: 27

Registration number BAT 3638

Current location Civic Centre, Geraldton

History This cannon was raised in 1963 and was registered into the collection of the Maritime Archaeology Department of WA Museum in April 1974. It is on loan to the Geraldton City Council. Initially on display outside the Country Women's Association Building in Geraldton, it was moved to the Geraldton Civic Centre sometime between 1984 and 1989. It was on display outside the centre, until being transferred to the arrivals terminal of Geraldton Airport in mid 2008.

Originally on display outside the centre, it was moved inside sometime between 1984 and 1989. In 1984, this cannon was treated by Jill Worsley and Jon Carpenter of the WA Museum's Department of Materials Conservation. A total of 4.28 kg of chloride ions was removed in a 360-day treatment program. After the extended washing period the cannon was given a protective coating and it was probably placed indoors upon return from its conservation treatment.

Description Bronze ship cannon from the Amsterdam Admiralty, made by Henricus Meurs in 1615.

Dimensions L. 3.20 m; bore diam. 0.151 m.



Batavia Bronze Ship Cannon

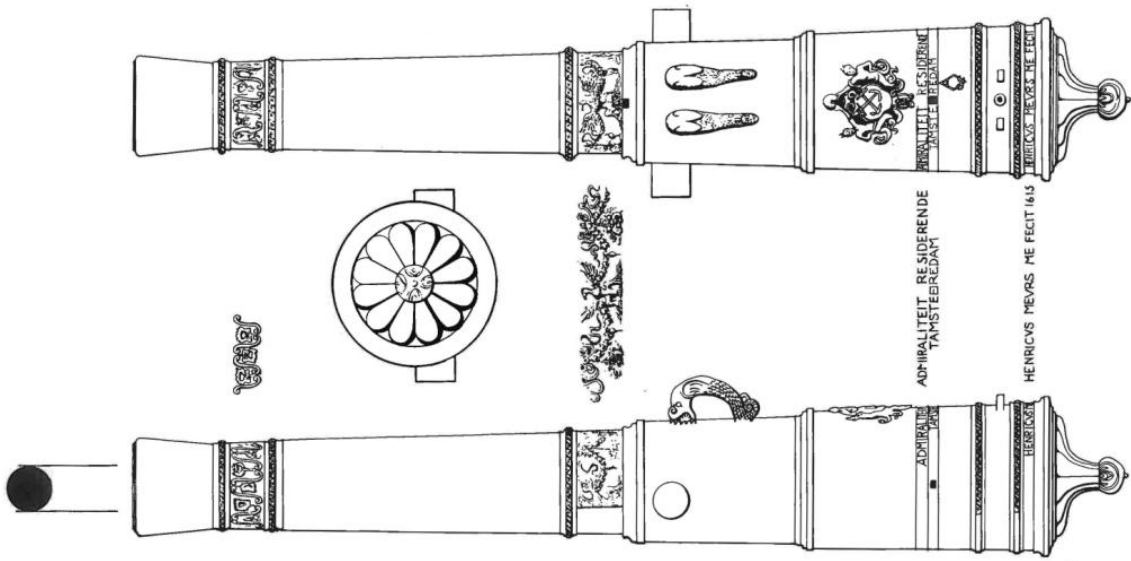

Green 1989: 33.

Batavia Bronze Ship Cannon

4.

Number on site plan: 28

Registration number BAT 3639

Current location

History

This cannon was raised in 1963 and was registered into the collection of the Maritime Archaeology Department of WA Museum in 1976. In 2011, it was transported from the HMAS Sterling naval base on Garden Island to the Shipwreck Galleries in Fremantle—it had been there since June 1993.

Description

Bronze ship cannon from the Amsterdam Admiralty, made by Henricus Meurs in 1615.

Dimensions

L. 3.30 m; bore diam. 0.15 m.

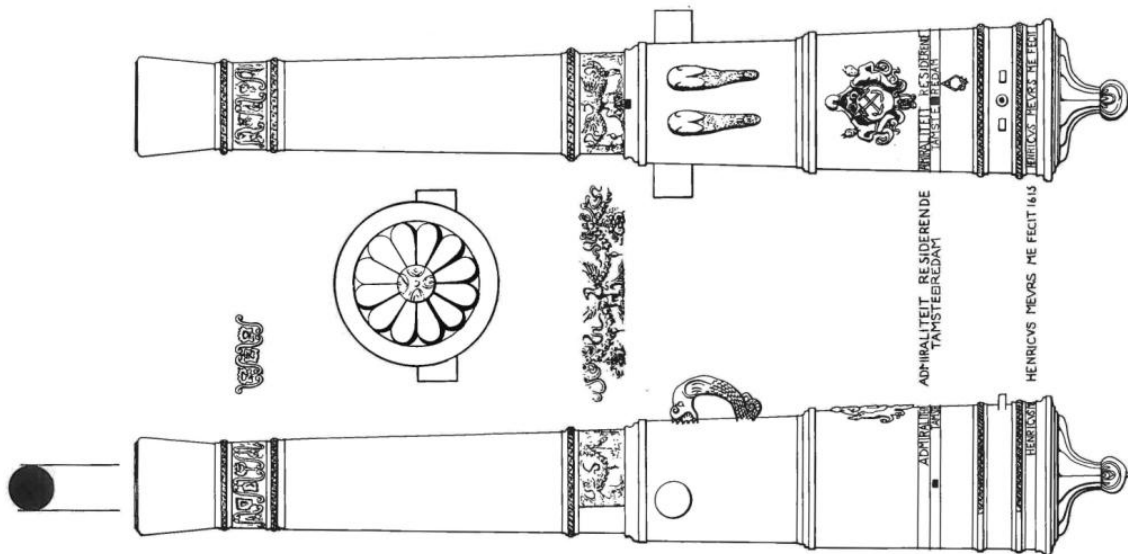

Batavia Bronze Ship Cannon

5.

Number on site plan: 26

Registration number BAT 3640

Current location Shipwreck Gallery, WA Museum Geraldton (left of the entrance into Shipwreck Gallery).

History This cannon was raised in 1970 by a Museum diving team (G. Kimpton and C. Powell) and is part of the collection of the Maritime Archaeology Department of WA Museum. It is the only bronze cannon from the *Batavia* shipwreck site raised by the WA Museum (Green 1989: 25).

Description Bronze ship cannon from the Rotterdam Admiralty, made by Arent van der Put in 1616.

Dimensions L. 3.18 m; bore diam. 0.152 m.



Batavia Bronze Ship Cannon

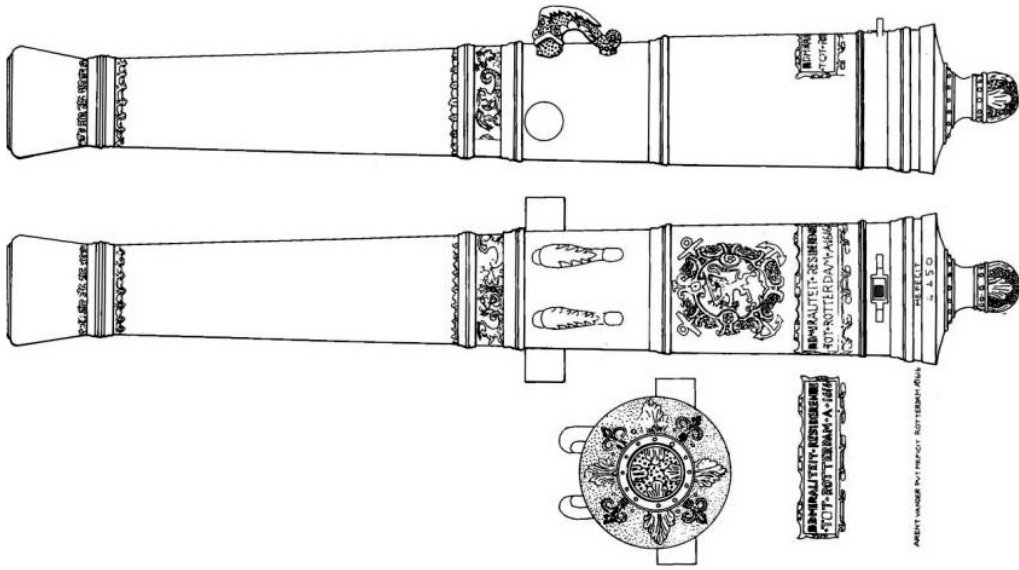

After Green 1989: 31

Note on BAT 3627: The vent and two chaplet holes are filled with wooden pegs (not iron, see Green 1989: 28), which are cracked.



Photo BAT3627.8



Photo BAT3627.9



Photo BAT3627.10



Photo BAT3627.11



Photo BAT3627.13

Batavia Composite Ship Cannon

Registration number BAT 3641

Location Shipwreck Gallery, WA Museum Geraldton (right of the entrance into Shipwreck Gallery)

Description Composite ship cannon, raised in 1963 by Gregg Allen, Graham Cramer, and Max Cramer. Owned by the Commonwealth, it is in the custodianship of Max Cramer. It is on display at the Shipwreck Gallery of the WA Museum in Geraldton since the 1970s and, therefore, was not declared in the 1976 Historic Shipwrecks Amnesty or the 1993/1994 Historic Shipwrecks Amnesty.

L. 2.284 m; bore diam. 0.147 m.

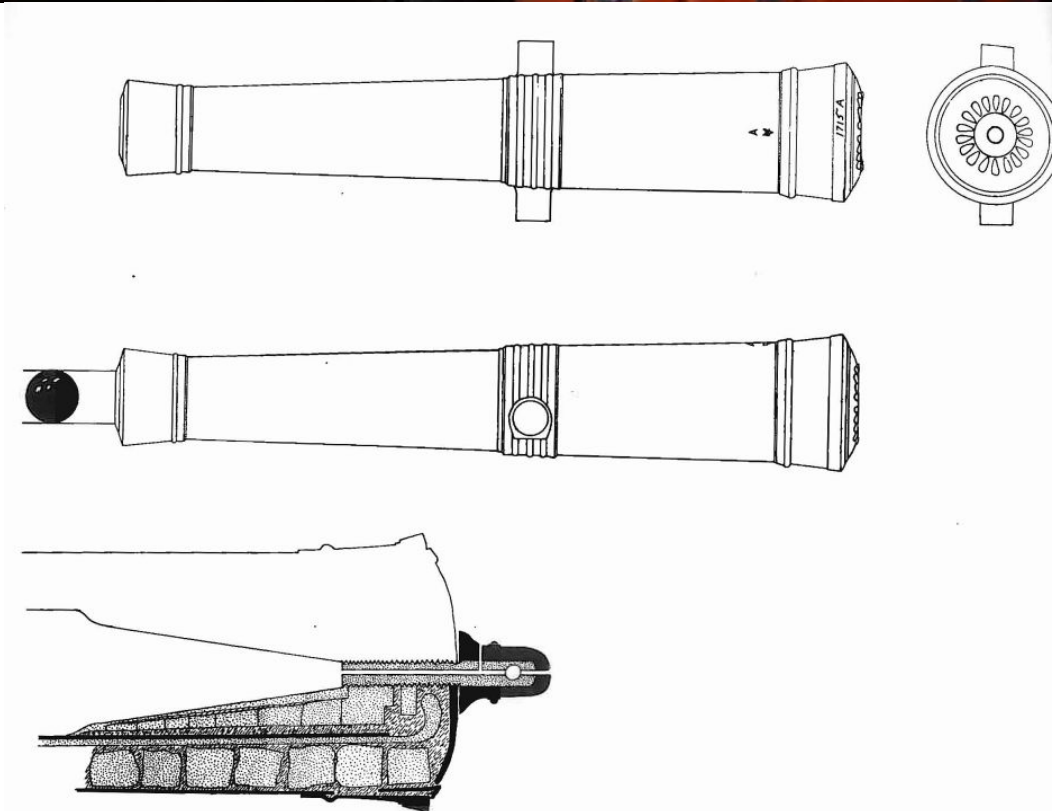

Batavia Composite Ship Cannon

Registration number BAT 3642 B

Location Shipwreck Gallery, WA Museum Geraldton

Description Composite ship cannon. Raised in 1971, it is part of the collection of Maritime Archaeology Department of WA Museum. One-fourth (cut-away section) of the cannon is on display in the Shipwreck Gallery of the WA Museum Geraldton.

[entire cannon] L. 2.284 m; bore diam. 0.147 m.



Registration number BAT 3642 B

Location *Batavia* Gallery, Shipwreck Galleries, WA Museum Fremantle

Description Composite ship cannon. Raised in 1971, it is part of the collection of Maritime Archaeology Department of WA Museum.

[entire cannon] L. 2.284 m; bore diam. 0.147 m.



Batavia Iron Ship Cannon

Batavia Iron Ship Cannon

1.

Number on site plan: 1

Registration number BAT 8720

Current location Department of Materials Conservation, WA Museum

History Raised from the shipwreck site by the WA Museum in March 1974. It is still undergoing conservation treatment.

Description Iron ship cannon

Dimensions Pres. l. 2.74 m; bore diam. 0.11 m. Pres. weight: 2838 kg.

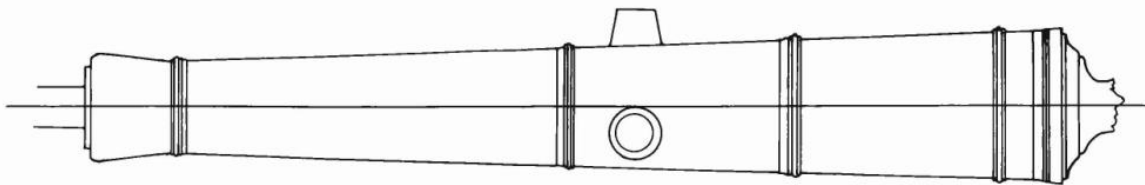

Green 1989: 47

Batavia Iron Ship Cannon

2.

Number on site plan: 2

Registration number BAT 8721

Current location Upper Gallery, Shipwreck Galleries, WA Museum, Fremantle

History Raised from the shipwreck site by the WA Museum in March 1974.

Description Iron ship cannon. Wadding from the cannon's bore was retrieved (BAT 4566).

Dimensions L. 2.78 m; bore diam. 0.125 m. Pres. weight: 3161 kg.

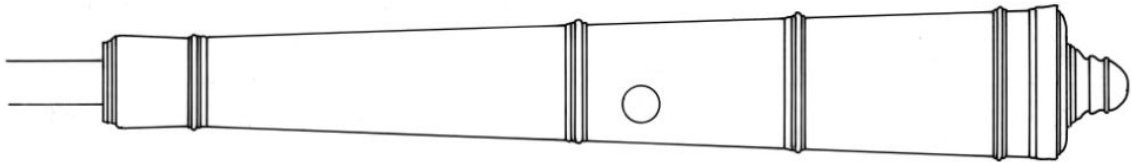

Green 1989: 47

Batavia Iron Ship Cannon

3.

Number on site plan: 3

Registration number BAT 8722

Current location Department of Materials Conservation, WA Museum

History Raised from the shipwreck site by the WA Museum in March 1974 in three parts. It is still undergoing conservation treatment.

Description Iron ship cannon. Its muzzle, found in a nearby concretion, is registered as BAT 3302. In design and size, it is very similar to BAT 8723 and almost certainly was one of an exact pair.

Dimensions Est. l. 2.57 m; bore diam. 0.11 m. Pres. weight: 2469 kg.

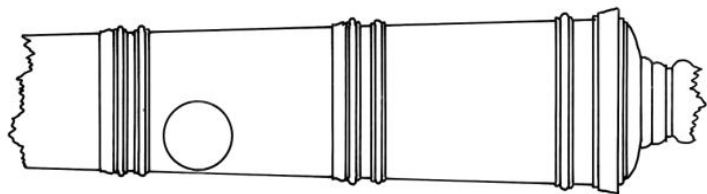
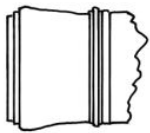

Green 1989: 47

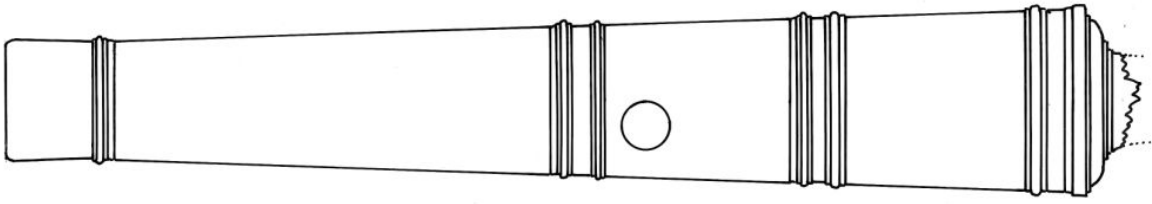
Batavia Iron Ship Cannon	
4.	Number on site plan: 4
Registration number	BAT 8723
Current location	Department of Materials Conservation, WA Museum
History	Raised from the shipwreck site by the Royal Australian Navy in March 1971. It is still undergoing conservation treatment.
Description	Iron ship cannon
Dimensions	L. 2.57 m; bore diam. 0.11 m (?). Pres. weight: 2713 kg.
	
Green 1989: 49	

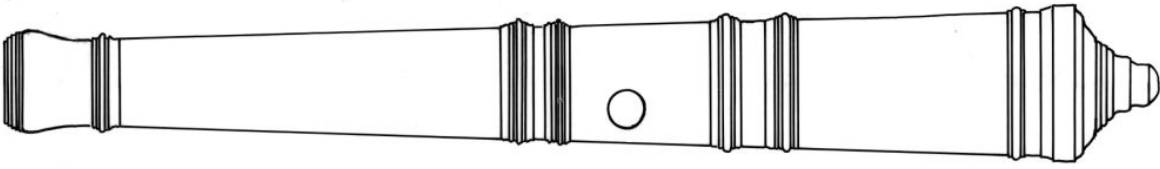
Batavia Iron Ship Cannon	
5.	Number on site plan: 5
Registration number	BAT 8724
Current location	<i>Batavia</i> Gallery, Shipwreck Galleries, WA Museum, Fremantle
History	Raised from the shipwreck site by the WA Museum in March 1973.
Description	Iron ship cannon. Its cascabel is missing.
Dimensions	L. 2.78 m; bore diam. 0.11 m. Pres. weight: 2375 kg.
	
Green 1989: 49	

Batavia Iron Ship Cannon

6.

Number on site plan: 8

Registration number BAT 8726

Current location Department of Materials Conservation, WA Museum

History Raised from the shipwreck site in 1970. It is still undergoing conservation treatment.

Description Iron ship cannon. Its cascabel is missing.

Dimensions L. 2.78 m; bore diam. 0.12 m. Pres. weight: 2889 kg.

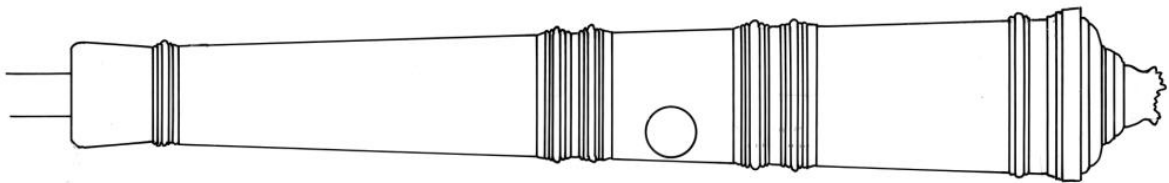

Green 1989: 47

Batavia Iron Ship Cannon

7.

Number on site plan: 13

Registration number BAT 8731

Current location Department of Materials Conservation, WA Museum

History Raised from the shipwreck site by the WA Museum in March 1973. It is still undergoing conservation treatment.

Description Iron ship cannon.

Dimensions L. 2.78 m; bore diam. 0.12 m. Pres. weight: 3269 kg.

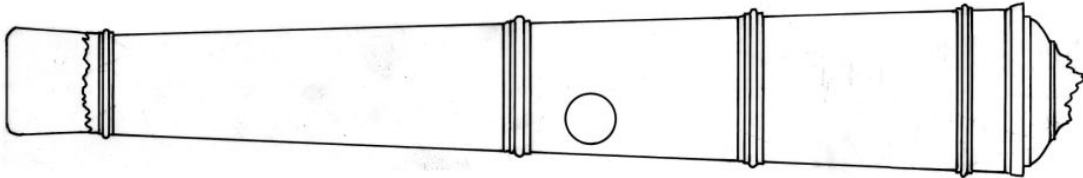

Green 1989: 51

Batavia Iron Ship Cannon

8.

Number on site plan: 23

Registration number BAT 8735

Current location South of Beacon Island

History This cannon was moved from the site during the first expedition in 1963 and has been kept in the shallows south of Beacon Island ever since (located off Dave Johnson Jetty). Custodianship of Dave Johnson.

Description Iron ship cannon.

Dimensions Pres. l. 2.43 m; bore diam. 0.095 m. Pres. weight: 1459 kg.

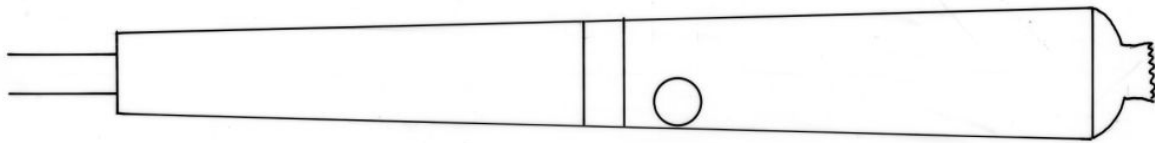

Green 1989: 51

Batavia Iron Ship Cannon

9.

Number on site plan: 20

Registration number BAT 80309

Current location *Batavia* Gallery, Shipwreck Galleries, WA Museum, Fremantle

History Raised from the shipwreck site Geoff Kimpton in 1971.

Description Iron ship cannon.

Dimensions L. 2.43 m; bore diam. 0.095 m. Pres. weight: 1518 kg.

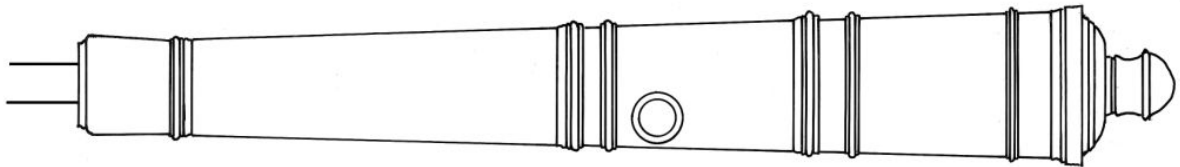

Green 1989: 51

Vergulde Draak Iron Ship Cannon

1.

Number on site plan: 25

Registration number Amnesty certificate WA 0681,1994 (not registered in the WA Museum's collection)

Current location Private collection [Kerry Stokes]

History Recorded in the custodianship of Robert Muir during the 1993/1994 Historic Shipwrecks amnesty. The cannon was the first to have been raised from the shipwreck site in 1963 or 1964 by James Henderson, John Cowen, and George Brenzi. After its salvage, it deteriorated rapidly not being subjected to conservation treatment. Without any of its marking and diagnostic features remaining, and entirely stripped of its surface, it was given to Robert Muir in the 1964 who placed it in his backyard. After his passing, the cannon was transferred to a private collection.

Description Iron ship cannon. The cipher of the Chamber of Amsterdam of the Dutch East India Company, "AVOC", was originally rendered in relief on the cannon's first reinforce, while the gun's weight in Amsterdam pounds was designated by "1700A" incised on the base ring of its breech. Initials cast on the cannon's trunnions, "48" on one and "ID" on the other, probably represent the date of its casting (1648) and the founder's initials. These markings are no longer visible, due to the gun's badly deteriorated condition.

Dimensions Pres. l. 2.311 m; diam. bore 0.101 m. Weight: Approx. 1,500 kg. (cf GT 1456). Original weight: 1,700 Amsterdam pounds (839.8 kg).

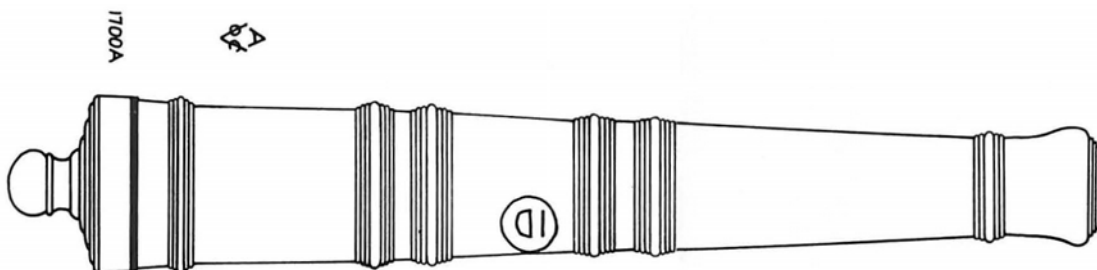

Vergulde Draak Iron Ship Cannon

1. Number on site plan: 25

Registration number GT 71, GT 72, GT 73, and GT 81

Current location Department of Maritime Archaeology, Shipwreck Galleries, WA Museum, Fremantle

History These fragments were registered in the WA Museum's collection in the 1966. In the registry books is written: "Cannon left in the open out open at the home of George Brenzi. Untreated fell into pieces." These fragments came from the cannon raised in 1963 or 1964 by Henderson, Brenzi and Cowen (Amnesty certificate WA 0681,1994)

Description The surface fragments of this iron ship cannon include small diagnostic pieces with the AVOC and 1700 marks.

Dimensions Pres. l. 2.311 m; diam. bore 0.101 m. Weight: Approx. 1,500 kg. (cf GT 1456). Original weight: 1,700 Amsterdam pounds (839.8 kg).

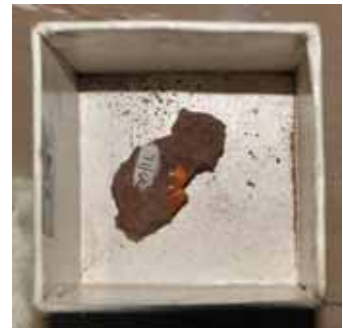

Vergulde Draak Iron Ship Cannon

2.

Number on site plan: 12

Registration number GT 1454

Current location Maritime Archaeology Collection Room 1, Department of Maritime Archaeology, Shipwreck Galleries, WA Museum Fremantle

History This cannon was raised by the Department of Maritime Archaeology of the WA Museum in 1972, during the first excavation season of the *Vergulde Draak* shipwreck.

Description Iron ship cannon. On its first reinforce, the cannon bears in relief the ciphers of the Amsterdam Chamber of the Dutch East India Company (AVOC) and Amsterdam Chamber of the West India Company (AGWC). The number 3230A, its weight in Amsterdam pounds, is incised on the base ring of the breech. The cannon is complete and in good condition. Part of its cascabel was found nearby (GT 1408)

Dimensions L. 2.87 m; diam. bore 0.125 m. Original weight 3230 Amsterdam pounds (1595.62 kg).

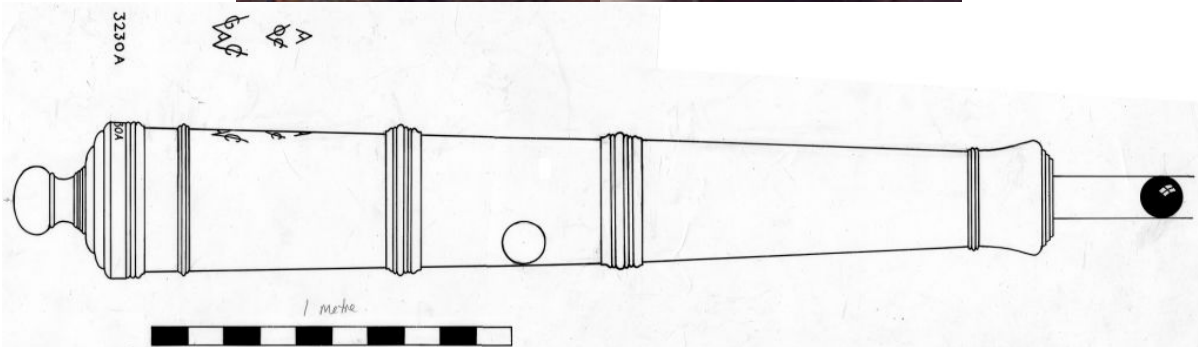

Vergulde Draak Iron Ship Cannon	
3.	Number on site plan: 16
Registration number	GT 1455
Current location	Department of Materials Conservation, WA Museum
History	This cannon was raised by the Department of Maritime Archaeology of the WA Museum in 1972, during the first excavation season of the <i>Vergulde Draak</i> shipwreck. It was placed in an inert alkaline environment and intended to be used for experimental work.
Description	Iron ship cannon, part only: one quarter. No visible markings, in poor condition.
Dimensions	-
[No Photo]	

Vergulde Draak Iron Ship Cannon

4.

Number on site plan: 13

Registration number GT 1456

Current location Hull Diorama, Shipwreck Gallery, WA Museum Geraldton

History Raised in March 1970.

Description Iron ship cannon. The cipher of the Chamber of Amsterdam of the Dutch East India Company, "AVOC", was originally rendered in relief on the cannon's first reinforce, while the gun's weight in Amsterdam pounds was designated by "1700A" incised on the base ring of its breech. Initials cast on the cannon's trunnions, "48" on one and "ID" on the other, probably represent the date of its casting (1648) and the founder's initials. These markings are no longer visible, due to the gun's badly deteriorated condition.

Dimensions L. 2.20 m; bore diam. unknown. Original weight: 1700 Amsterdam pounds (839.8 kg).

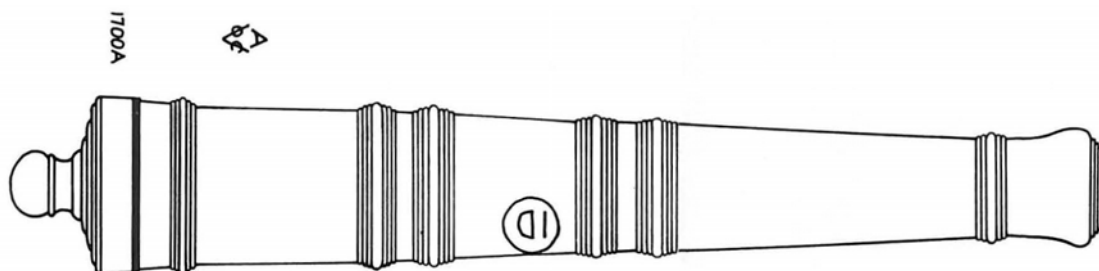

Green 1977: 271

ZUIDDORP 1712

Zuiddorp Bronze Ship Cannon	
1.	Number on site plan: -
Registration number	ZT 726 (Part)
Current location	Shipwreck Gallery, WA Museum Geraldton
History	It was found, filled with silver coins, on the shipwreck site by WA Museum divers Geoff Kimpton and Harry Bingham in the 1970s. The main section of this cannon is on display in the upstairs administration area of the WA Museum in Geraldton, whereas smaller fragments are on display in the WA Museum's Shipwreck Galleries in Fremantle.
Description	Bronze ship cannon, section. Severely eroded and poorly preserved.
Dimensions	Pres. l. 1.24 m; bore diam. 0.11 m.
	
Administration area of the WA Museum in Geraldton	
	
Upper Gallery, Shipwreck Galleries, WA Museum Fremantle	

Zuiddorp Bronze Swivel Gun

1. Number on site plan: -

Registration number Amnesty certificate WA 0559,1994

Current location Private collection [Max Cramer]

History Found in 1963 by Max Cramer on the shipwreck site with the ship's lead ingots seaward of *Zuiddorp's* stern.

Description Bronze muzzle-loading swivel gun, severely eroded. No original surface remaining; no markings or other diagnostic features.

Dimensions Pres. l. 0.63 m; bore diam.



Zuiddorp Bronze Swivel Gun

2.

Number on site plan: -

Registration number Amnesty certificate WA 0560,1994

Current location Private collection [Max Cramer]

History Found in 1963 by Max Cramer on the shipwreck site with the ship's lead ingots seaward of *Zuiddorp's* stern.

Description Bronze muzzle-loading swivel gun, severely eroded. 'Bronze' disease patches. No original surface remaining; no markings or other diagnostic features.

Dimensions Pres. l. 0.73 m; bore diam.



Zuiddorp Bronze Swivel Gun

3.

Number on site plan: -

Registration number ZT 2402

Current location Shipwreck Gallery, WA Museum Geraldton (Display ZT 9)

History Found in 1963 by Max Cramer on the shipwreck site with the ship's lead ingots seaward of *Zuiddorp's* stern. It is in the custody of Max Cramer (Amnesty certificate WA 0561, 1994).

Description Bronze muzzle-loading swivel gun, eroded. No original surface remaining; no markings or other diagnostic features.

Dimensions Pres. l. 0.58 m; bore diam. 0.045 m.



Zuiddorp Bronze Swivel Gun

4.

Number on site plan: -

Registration number ZT 2409

Current location Upper Gallery, Shipwreck Galleries, WA Museum, Fremantle

History Recovered from end of jetty at Denham. Shark Bay in 2 m of water, 400 m offshore on 17 June [or September] 1979. It was placed there by Alan Robinson.

On Police firearms list, checked 13/8/96. Their description- `Cannon, Dutch, 2 1/2 inch`. Showcase label needs correcting. Loan Inv. 13217.

Description Swivel gun, bronze muzzle-loading. Marked: ZVOC M (Zeeland Chamber of the VOC, Middelburg). The castle stamped beneath it is the control mark of the Middelburg foundry.

Dimensions L. 0.87 m; bore diam 0.05 m

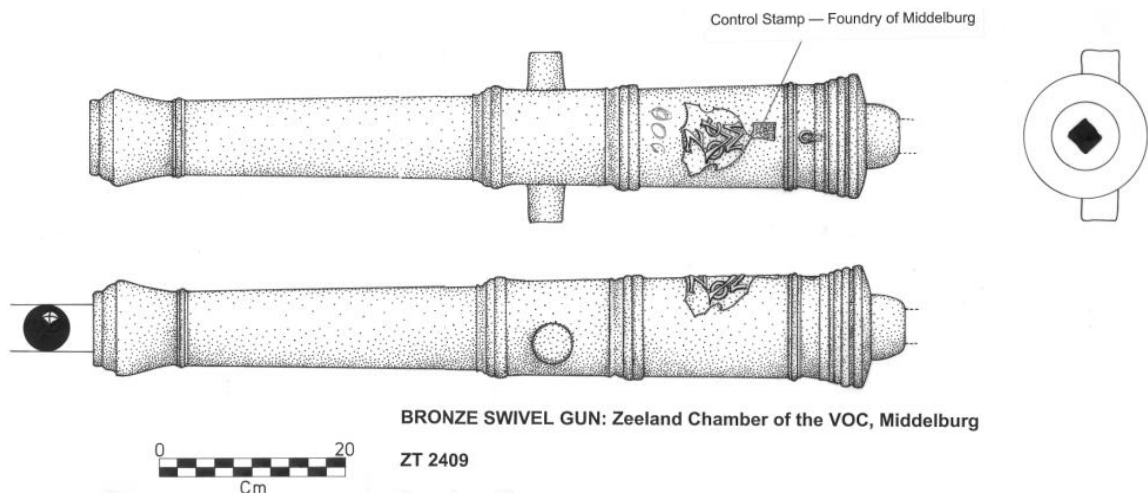

Zuiddorp Bronze Swivel Gun

5. Number on site plan: -

Registration number ZT 3277

Current location Upper Gallery, Shipwreck Galleries, WA Museum Fremantle

History This fragmentary section of a swivel gun was raised from the shipwreck site in 1986 by the Department of Maritime Archaeology of the WA Museum.

Description Bronze breech-loading swivel gun, eroded. Partially preserved: only centre section with eroded trunnions. No original surface remaining; no markings or other diagnostic features.

Dimensions [\[add dimensions\]](#)



Zuiddorp Bronze Swivel Gun

6.

Number on site plan: -

Registration number ZT 3313

Current location Upper Gallery, Shipwreck Galleries, WA Museum Fremantle

History Collected 1987 Finder: Simon Jones

On Police fire arms list, checked 13/8/96. Their description-
`Cannon, Dutch, 2inch.

Description Bronze muzzle-loading swivel gun, severely eroded.

Dimensions Pres. l. 0.84 m; diam. bore approx. 0.064 m

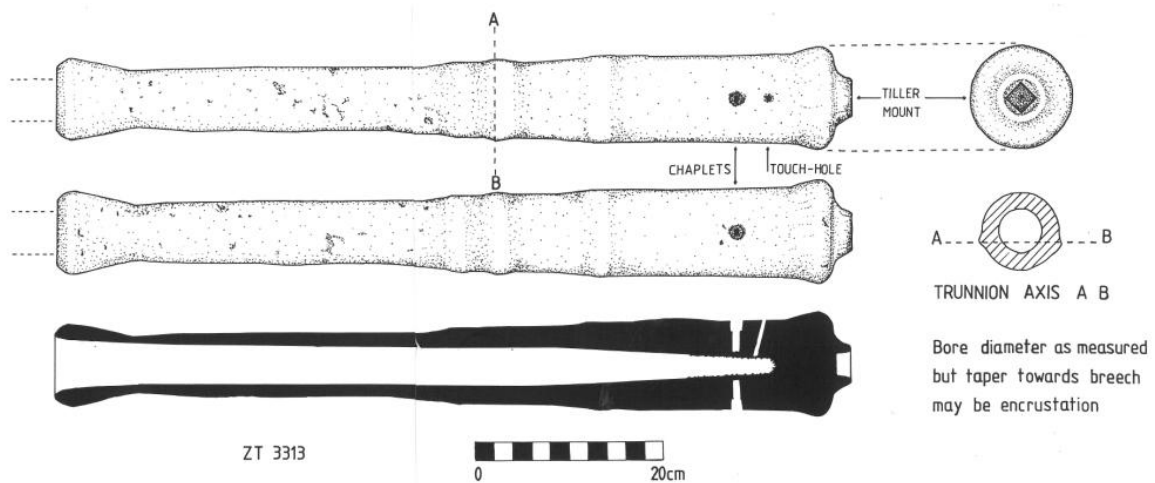

Zuiddorp Bronze Swivel Gun

7. Number on site plan: -

Registration number ZT 3925

Current location Upper Gallery, Shipwreck Galleries, WA Museum Fremantle

History This fragmentary section of a swivel gun was **illegally??** collected from the shipwreck site in 1988 [by Bob Mitchell] and donated to the Department of Maritime Archaeology of the WA Museum.

Description Bronze **breech-loading or muzzle-loading** swivel gun, eroded. Partially preserved: only muzzle remaining. No original surface remaining; no markings or other diagnostic features.

Dimensions [add dimensions]



Zuiddorp Bronze Swivel Gun

8.

Number on site plan: -

Registration number ZT 4161

Current location Department of Maritime Archaeology, Shipwreck Galleries, WA Museum, Fremantle

History This fragmentary section of a swivel gun was raised from the shipwreck site in February 1992 by the Department of Maritime Archaeology of the WA Museum. It was found at *Zuiddorp's* stern in the gun/ingot area (26/32).

Description Bronze muzzle-loading swivel gun, eroded. Partially preserved: 2/3 worn away.

Dimensions Pres. l. 0.82 m; diam. bore 0.045 m. Pres. weight: 13.00 kg



Zuiddorp Iron Cannon

1. Number on site plan: -

Registration number ZT 3926

Current location Upper Gallery, Shipwreck Galleries, WA Museum Fremantle

History This cannon was raised from the shipwreck site in February 1988 by the WA Museum. It was found at the low area of the *Zuiddorp* site.

Description Iron ship cannon, well preserved. As found, the cannon was loaded ready for action with a cannonball, charge, and wadding inside the bore. These were found behind the tompion (a wooden plug to keep bore dry) that effectively sealed the bore and its contents for over two centuries. The 'Broad Arrow' on the cannon's upper surface indicated that gun was the British, possibly acquired by trade or as spoils of war.

Dimensions L. 2.59 m; diam. bore 0.108–0.155 m.



Zuiddorp Iron Cannon

2.

Number on site plan: -

Registration number ZT 3314

Current location Maritime Archaeology Department, MAC-091, On top of cupboard

History This cannon was raised from the shipwreck site on 13 March 1987 by the Department of Maritime Archaeology of the WA Museum.

Description Iron ship cannon remains of worn section. No original surface remaining; no markings or other diagnostic features.

Dimensions Pres. l. 0.475; bore diam. 0.105

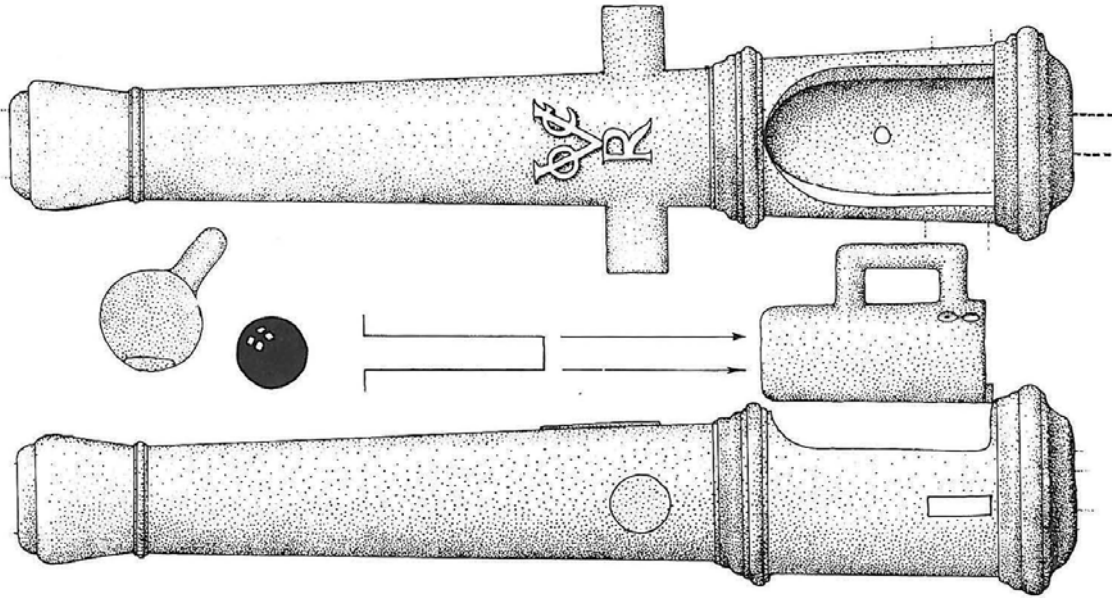

ZEEWIJK 1727

Zeewijk Bronze Swivel Gun	
1.	Number on site plan: -
Registration number	ZW 1049
Current location	Shipwreck Gallery, WA Museum Geraldton (Display ZW 17)
History	It was found northwest of Gun Island on inside of main reef, approx. 300–400 m north of cannon believed to be <i>Zeewijk</i> . The gun was recovered by Messrs John A. and Enrico (Ric) Boschetti in May 1968, and donated to the WA Museum by the Boschetti family. Ex-gratia reward of \$200 paid to finders (See WA Museum, file MA-466/71)
Description	Bronze swivel gun, breech-loading, eroded. Marked: AVOC R. It fits with breech block ZW 1050. Both are on display in the Shipwreck Gallery of the WA Museum Geraldton.
Dimensions	Pres. l. 1.08 m; bore diam. 0.07 m.
	
	

Zeewijk Bronze Swivel Gun	
2.	Number on site plan: -
Registration number	ZW 1111
Current location	Tower of London
History	Discovered on 24 April 1840 on the largest island (promptly named Gun Island) of the Pelsart Group by John Lort Stokes and the crew of the British survey ship HMS <i>Beagle</i> (Stokes 1846: 149). The ship's crew landed on the island where the marooned sailors from the <i>Zeewijk</i> had camped more than 100 years earlier (Blackmore 1976: 50–51).
Description	<p>From Blackmore 1976: 50–51: “Bronze breech-loading swivel gun (2^{3/4}-pounder), Dutch (Middelburg), dates to c. 1670. The chase bears in relief the cipher of the Zeeland Division of the Dutch East India Company (ZVOC), the second reinforce is stamped with the control mark of the foundry of Middelburg, the capital of the province of Zeeland, and the number 182A, the weight in Amsterdam pounds, is incised just in front of the breech opening. The cascabel is chased with acanthus foliage. There is an iron traversing lever, now corroded and split and bent into an upward curve, which may or may not be the original shape. There are two slots in the base of the breech for the wedge securing the chamber and a third slot in the underside; these slots are usual in this type of gun. The trunnions are fitted with an iron pivot, of which much of the spike is missing. An original chamber is preserved. Made of metal similar to that of the gun, it is of smaller internal diameter than the bore, tapers slightly from base to mouth and has a rectangular lifting handle; the base has a projecting lip to engage with the securing wedge. The chamber bears a repetition of the control mark on the gill. The vent is spiked.</p> <p>The maker of the gun may have been Johannes Burgerhuys who worked at Middelburg as a naval gun and bell founder until his death in 1679 when the foundry was closed. It was not until 1754 that another gun foundry was established in the town.</p>
Dimensions	L. 1.118 m (1.219 m including cascabel); cal 2.9 in (0.074 m); l. breech chamber 0.229 m; diam. bore 0.033 m. Original weight: 89.9 kg.

Zeewijk Bronze Swivel Gun

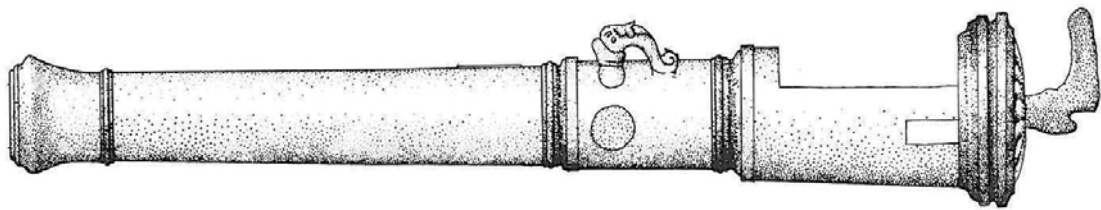
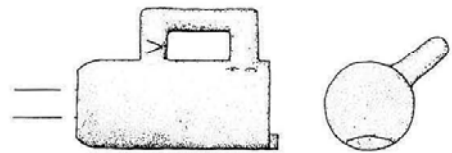
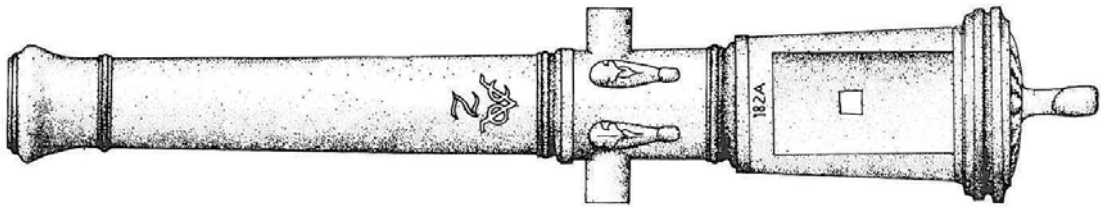
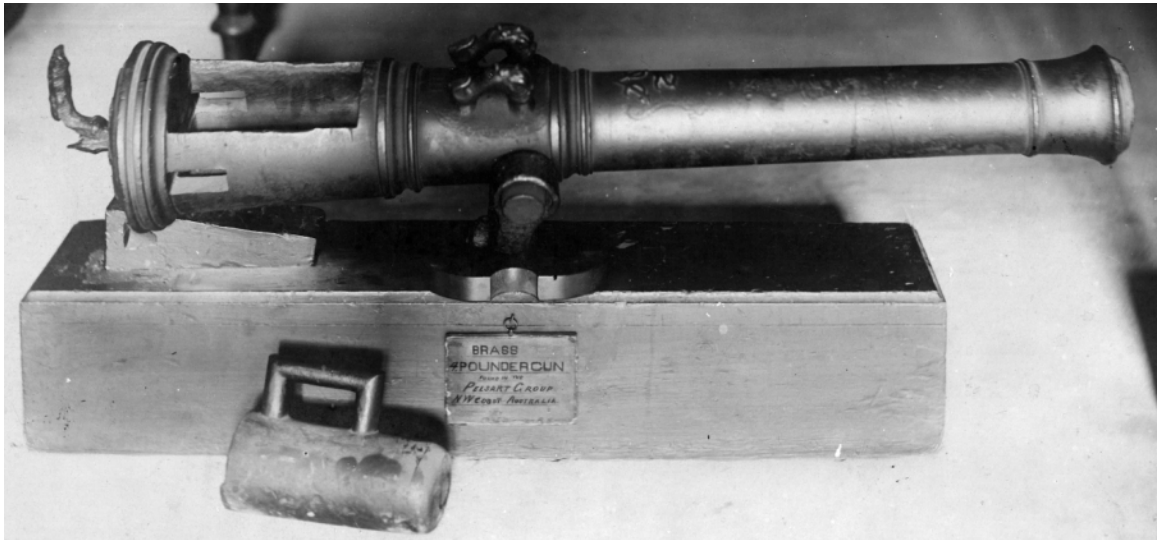

Zeewijk Bronze Swivel Gun

3.

Number on site plan: -

Registration number ZW 1345

Current location Department of Maritime Archaeology, Shipwreck Galleries, WA Museum Fremantle

History Raised from area 4 of the shipwreck site in 1976 by the Department of Maritime Archaeology of the WA Museum.

Description Bronze swivel gun, breech-loading, eroded. Partially preserved; only first reinforce is remaining.

Dimensions Pres. l. 0.34 m; bore diam. 0.11 m.



Zeewijk Bronze Swivel Gun

4.

Number on site plan: -

Registration number ZW 2163

Current location Department of Maritime Archaeology, Shipwreck Galleries, WA Museum Fremantle

History 12 April 1977 or 1971???? south main area

Description Bronze swivel gun, breech-loading, eroded. Partially preserved; only second reinforce section with both trunnions is remaining.

Dimensions Pres. l. 0.185 m; bore diam. 0.075–0.12 m.



Zeewijk Iron Ship Cannon

1. Number on site plan: -

Registration number ZW 5572

Current location Passageway, Shipwreck Galleries, WA Museum

History This cannon was raised by the R.A.N. in 1952 and delivered to the WA Museum. As evidence of corrosion became apparent, they were buried 1m in the Museum grounds to exclude oxygen. Water was sprinkled over the top soil in an endeavour to remove salt contamination. This spraying was continued for several months then ceased. In 1958 the cannon were dug out, given a phosphoric acid inhibitor treatment, and placed on display in the Museum grounds. The cannon were subsequently returned to the Conservation Laboratory but have not undergone further treatment.

Description Iron ship cannon (12-pounder), underside worn but some surface features still intact.

Dimensions Pres. l. 2.86 m; pres. diam. bore 0.11 m (concreted inside)



Zeewijk Iron Ship Cannon

2.

Number on site plan: -

Registration number ZW 5573

Current location Maritime Archaeology Collection Room 2, Department of Maritime Archaeology, Shipwreck Galleries, WA Museum, Fremantle

History This cannon was raised by the R.A.N. in 1952 and delivered to the WA Museum. As evidence of corrosion became apparent, they were buried 1m in the Museum grounds to exclude oxygen. Water was sprinkled over the top soil in an endeavour to remove salt contamination. This spraying was continued for several months then ceased. In 1958 the cannon were dug out, given a phosphoric acid inhibitor treatment, and placed on display in the Museum grounds. The cannon were subsequently returned to the Conservation Laboratory but have not undergone further treatment.

Description Iron ship cannon (eight-pounder): eroded. Muzzle section and trunnions worn away.

Dimensions Pres. l. 2.41 m; pres. diam. bore 0.07 m (concreted inside); original diam. bore 0.115 m.



Zeewijk Iron Ship Cannon

3.

Number on site plan: -

Registration number

ZW 5575
1985 Netherlands Govt. Allocation

Current location

Maritime Archaeology Collection Room 1, Department of Maritime Archaeology, Shipwreck Galleries, WA Museum, Fremantle

History

Raised by Hugh Edwards and the W.A Newspapers in 1963. Remained in yard at rear of W.A. Newspapers until sent to the scrap metal dealer Krasnostein at the end of 1967. The Museum was informed of this and took possession in 1968.

Description

Iron ship cannon, poorly preserved; pitted and eroded. No original surface remaining; no markings or other diagnostic features.

Dimensions

Pres. l. 2.4 m; bore pres. diam. 0.90 m (concreted inside)



Zeewijk Iron Ship Cannon

4.

Number on site plan: -

Registration number ZW 5574
1985 Commonwealth Govt. Allocation: ANMM (00046485)

Current location Australian National Maritime Museum, Sydney

History Raised by Hugh Edwards and the W.A Newspapers in 1963. Remained in yard at rear of W.A. Newspapers until sent to the scrap metal dealer Krasnostein at the end of 1967. The Museum was informed of this and took possession in 1968.

Description Iron ship cannon, poorly preserved; pitted and eroded. No original surface remaining; no markings or other diagnostic features.

Dimensions L. 2.4 m; bore diam. 0.90 m



Zeewijk Iron Ship Cannon

5.

Number on site plan: -

Registration number ZW 5578

Current location Marine Terrace, Geraldton

History

It is currently situated on Marine Terrace, Geraldton. The cannon was raised in 1962 by Trevor Sutcliffe off Geraldton and left in the council yard. It was then moved to the RSL Hall before going to another yard. A scrap metal dealer than bought it for \$10.00 and then offered it for sale to Max Cramer for \$20.00. The Tourist Bureau eventually bought it for \$20.00 and it is now on display outside the Geraldton Library and Tourist Centre (Stanbury 1985: 32 and 34).

Owned by the Commonwealth and registered in the collection of the WA Museum, this cannon is in the custodianship of the Geraldton Library and Tourist Centre. There is no record of this cannon being declared in the 1993/1994 Historic Shipwrecks Amnesty.

Description

Iron ship cannon, poorly preserved and pitted. No original surface remaining; no markings or other diagnostic features.

Dimensions

Pres. l. 2.40 m; diam. bore 0.11 m.

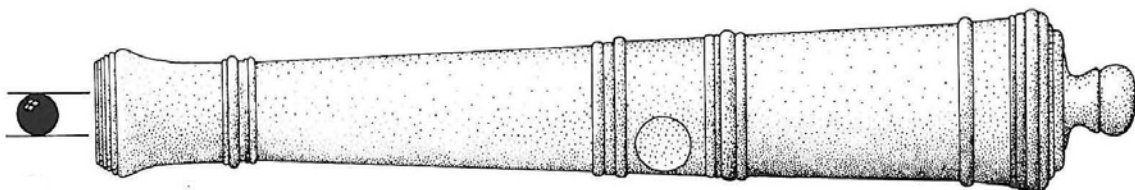

REFERENCED WORKS

- Blackmore, H.L. *The Armouries of the Tower of London: The Ordnance*. London: Her Majesty's Stationary Office, 1976.
- Bruijn, Jacobus R., Femme S. Gaastra, and Ivo Schöffer. *Dutch-Asiatic Shipping in the 17th and 18th Centuries: Outward-bound Voyages from the Netherlands to Asia and the Cape (1595–1794)*. Rijks geschiedkundige publicatiën: Uitgegeven in opdracht van de minister van onderwijs en wetenschappen onder toezicht van de Rijkscommissie voor Vaderlandse Geschiedenis, grote serie, 166. Vol. 2. The Hague: Martinus Nijhoff, 1979.
- Green, Jeremy N. *The Loss of the Verenigde Oostindische Compagnie Retourschip Batavia, Western Australia 1629: An Excavation Report and Catalogue of Artifacts*. BAR International Series 489. Oxford, England: British Archaeological Reports, 1989.
- _____. *The Loss of the Verenigde Oostindische Compagnie Jacht Vergulde Draeck, Western Australia 1656: A Historical Background and Excavation Report with an Appendix on Similar Loss of the Fluit Lastdrager*. 2 vols. BAR Supplementary Series, 36. Oxford, England: British Archaeological Reports, 1977.
- Historic Shipwrecks Act 1976* (Act No. 190 of 1976 as amended 2006). See: <http://www.comlaw.gov.au/comlaw/management.nsf/lookupindexpagesbyid/IP200401441?OpenDocument>.
- Ingelman-Sundberg, Catharina. *The Dutch East Indiaman Zeewijk Wrecked in 1727: A Report on the 1978 Expedition to the Site*. Report, no. 10. Perth: Department of Maritime Archaeology, Western Australian Museum, 1978.
- _____. "The VOC Ship Zeewyk Lost off the Western Australian Coast in 1727: An Interim Report on the First Survey." *IJNA* 6, no. 3 (1977): 225–32.
- National Archives (NA) of the Netherlands, The Hague, *Archieven van de Verenigde Oostindische Compagnie, 1602–1795*, reference code 1.04.02, item number 267 (Minutes of Gentlemen XVII), 1725.
- Playford, Phillip E. *Carpet of Silver: the Wreck of the Zuytdorp*. Original edition, 1996. Reprint, Crawley: University of Western Australia Press, 2006.
- Roeper, Vibeke. *De schipbreuk van de Batavia, 1629*. De Linschoten-Vereeniging, 92. Zutphen, the Netherlands: Walburg Pres, 1993.
- Stanbury, Myra,. *ANCODS Catalogue*. Special Publication, no. 6. Fremantle: Department of Maritime Archaeology, Western Australian Museum, 1985.
- Stokes, J.L. *Discoveries in Australia; with an Account of the Coasts and Rivers Explored and Surveyed during the Voyage of the H.M.S. Beagle, in the Years 1837–43*. London: T. and W. Boone, 1846.
- Van Dam, Pieter. *Beschrijvinge van de Oostindische Compagnie*, edited by Frederik W. Stapel. Rijks geschiedkundige publicaten: Uitgegeven in opdracht van z. Exc. den minister van onderwijs, kunsten en wetenschappen, 63. Vol. 1.1. The Hague: Martinus Nijhoff, 1927.

FURTHER READING

Green, Jeremy N. "Note on the Guns from the VOC Ship *Batavia*, Wrecked off the Western Australian Coast in 1629." *IJNA* 17, no. 1 (1988): 103.

_____. "The Armament from the *Batavia*: 1. Two Composite Guns." *IJNA* 9, no. 1 (1980): 43–52.

\

¹ A detailed report on each *Batavia* cannon can be found in Green 1989. Bronze cannon were expensive and, generally, only placed in areas in the direct vicinity of the compass (on the quarterdeck fore of the cabin). Two bronze Rotterdam Admiralty cannon, BAT 3640 and BAT 3627, and two composite cannon, BAT 3742 and BAT 3641, were recovered in *Batavia*'s stern area, whereas the three remaining bronze cannon, BAT 3637, BAT 3638 and BAT 3639, were found in the bow area. The first is a Rotterdam Admiralty cannon, and the latter two were Amsterdam Admiralty cannon. It is likely that the bronze cannon, recovered by Pelsaert, was the counterpart for the Rotterdam Admiralty cannon in the ship's bow.

² Their weight was mostly likely listed in Amsterdam pounds (1 Amsterdam pound = 0.494 kilograms).

³ ANCODS: Australian Netherlands Committee on Old Dutch Shipwrecks.